

# Data Sheet

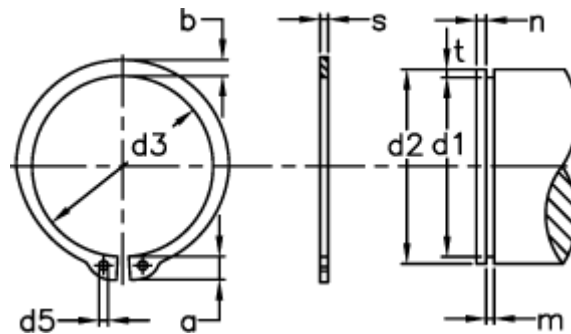

Article number: 0109042  
 Description: Retaining ring AS 25x2.0  
 Spring steel  
 Note: Fitted with ZGA pliers

## Measures



a max	= 6.4	Description	= AS 25	s	= 2.00
AN mm <sup>2</sup>	= 49.7	FN kN	= 8.30	t	= 0.55
B	= 2.78	FRg kN	= 10.3	tol	= -0.21
b	= 3.4	FR kN	= 45.0	tol	= -0.07
d1	= 23.9	g	= 1.5	tol	= +0,21 -0,42
d2	= 25	m min	= 2.15	Tong	= ZGA-2
d3	= 23.2	n abl x 1000	= 25	Weight kg/1000	= 3.35
d5 min	= 2.0	Nominal drive	= 1.9		